



Bagless Stick Vac

OWNER'S MANUAL

Model FS800

120V., 60Hz., 7.5 Amps.



FANTOM

94 Main Mill Street, Door 16
Plattsburgh, NY 12901
Tel.: 1 (800) 275-9251
www.fantom.com



ONE (1) YEAR LIMITED WARRANTY

FANTOM warrants this product to be free from defects in material and workmanship for a period of one (1) year from the date of the original purchase, when utilized for normal household use, subject to the following conditions, exclusions and exceptions.

If your appliance fails to operate properly while in use under normal household conditions within the warranty period, return the complete appliance and accessories, freight prepaid to:

FANTOM, 94 Main Mill Street, Door 16, Plattsburgh, N.Y. 12901

If the appliance is found by **FANTOM** to be defective in material or workmanship, **FANTOM** will repair or replace it free of charge. Proof of purchase date and \$ 9.95 to cover the cost of return shipping and handling must be included. *

Non-durable parts including, without limitation, filters, brushes and electrical parts which normally require replacement are specifically excluded from warranty.

The liability of **FANTOM** is limited solely to the cost of the repair or replacement of the unit at our option. This warranty does not cover normal wear of parts and does not apply to any unit that has been tampered with or used for commercial purposes. This limited warranty does not cover damage caused by misuse, abuse, negligent handling or damage due to faulty packaging or mishandling in transit. This warranty does not cover damage or defects caused by or resulting from damages from shipping or repairs, service or alterations to the product or any of its parts, which have been performed by a repair person not authorized by **FANTOM**.

This warranty is extended to the original purchaser of the unit and excludes all other legal and/or conventional warranties. The responsibility of **FANTOM** if any, is limited to the specific obligations expressly assumed by it under the terms of the limited warranty. **In no event is FANTOM** liable for incidental or consequential damages of any nature whatsoever. Some states do not permit the exclusion or limitation of incidental or consequential damages, so the above may not apply to you.

This warranty gives you specific legal rights, and you may also have other rights which vary from state to state.

***Important: Carefully pack item to avoid damage in shipping. Be sure to include proof of purchase date and to attach tag to item before packing with your name, complete address and phone number with a note giving purchase information, model number and what you believe is the problem with item. We recommend you insure the package (as damage in shipping is not covered by your warranty). Mark the outside of your package "ATTENTION CUSTOMER SERVICE". We are constantly striving to improve our products, therefore the specifications contained herein are subject to change without notice.**

TROUBLE SHOOTING GUIDE

PROBLEM	POSSIBLE REASON	POSSIBLE SOLUTION
VACUUM WILL NOT OPERATE	<ol style="list-style-type: none"> Power cord not firmly plugged into outlet. No power in wall outlet. Needs servicing. Thermostat has tripped. 	<ol style="list-style-type: none"> Plug unit in firmly. Check fuse or breaker. Replace fuse/reset breaker. Call 1-800-275-9251. Turn the unit off and unplug from outlet. Allow unit to cool down, then restart.
VACUUM WILL NOT PICK-UP OR SUCTION POWER IS WEAK	<ol style="list-style-type: none"> Dust cup is full. Unit clogged. HEPA-Type Filter needs cleaning or replacing. Debris screen needs cleaning. 	<ol style="list-style-type: none"> Empty and clean dust cup. Turn unit off and unplug from wall outlet. Remove Dust Cup Filter and check for object(s) in air duct and remove. Clean or replace HEPA-Type Filter. Clean debris screen.
DUST ESCAPING FROM VACUUM	<ol style="list-style-type: none"> Dust cup is full. Dust Cup is not installed correctly. 	<ol style="list-style-type: none"> Empty and clean dust cup. Review Dust Cup instructions.
VACUUM, HOSE OR BRUSHES WILL NOT PICK-UP	<ol style="list-style-type: none"> Hose clogged. Dust cup is full. 	<ol style="list-style-type: none"> Remove hose and/or brushes. Remove obstruction from hose and /or brush. Empty and clean dust cup.

ORDERING REPLACEMENT DUST CUP FILTERS

TO ORDER REPLACEMENT HEPA-TYPE FILTERS for Model FS800

Call: 1 (800) 275-9251

Monday to Friday 8:30 A.M. - 5:00 P.M. Eastern Standard Time

FOR TECHNICAL SUPPORT for Model FS800

Call: 1 (800) 275-9251

Monday to Friday 8:30 A.M. - 5:00 P.M. Eastern Standard Time

or
visit our website: www.fantom.com

Please Note:

The HEPA-TYPE Filter is washable. It should, however, be replaced every three (3) months to ensure peak performance of your vacuum.

Both the Pre-Motor and Post Motor Filters are washable. They should however be replaced every three (3) months to ensure peak performance of your vacuum.

Important:

Make sure that **ALL** filters have been completely air dried for 24 hours before re-installing back in the vacuum.

IMPORTANT SAFETY INSTRUCTIONS

When using your **BAGLESS STICK VAC** basic safety precautions should always be observed, including the following:

- Read all instructions before using your **BAGLESS STICK VAC**.
- Use the system only for its intended use.
- To protect against a risk of electric shock, do not immerse any part of the system in water or other liquids.
- Never yank cord to disconnect from outlet; instead, grasp plug and pull to disconnect.
- Do not** allow cord to touch hot surfaces.
- Do not** run appliance over cord.
- Do not** operate the system with a damaged cord or plug, or if the appliance or any other part of the system has been dropped or damaged. To avoid the risk of electric shock, do not disassemble or attempt to repair the **BAGLESS STICK VAC**. Return the system to **FANTOM** (see warranty) for examination and repair. Incorrect re-assembly or repair can cause a risk of electrical shock or injury to persons when the **BAGLESS STICK VAC** is used.
- Close supervision is necessary for any appliance being used by or near children. Do not leave the system unattended while connected.
- Keep hair, loose clothing, fingers and all parts of body away from opening and moving parts.
- Do not** use to pick up flammable or combustible liquids such as gasoline or use in areas where they may be present.
- Do not** pick up anything that is burning or smoking such as cigarettes, matches or hot ashes.
- Use extra care when cleaning on stairs.
- Do not** use the hand vacuum without the HEPA-TYPE dust cup filter in place.
- This appliance is intended only for household use. Follow all user instructions in this manual.

To reduce the risk of fire, electric shock, or injury:

- Do not** leave the **BAGLESS STICK VAC** plugged in when unattended. Unplug the electrical cord when not in use and before servicing.
- Do not** allow to be used as a toy. Close attention is necessary when used by or near children, pets or plants.
- Use only as described in this manual. Use only manufacturer's recommended accessories.
- Do not** pull cord, use cord as a handle, close a door on cord, or pull cord around sharp edges or corners. Keep cord away from heated surfaces.
- Use **only** extension cords UL-rated or cUL at 15 amperes. extension cords rated for less amperage may overheat. Care should be taken to arrange the cord so that the cord cannot be pulled or tripped over.
- Turn off all controls as applicable before unplugging from electrical outlet.
- Do not** unplug by pulling on cord. To unplug, grasp the plug, not the cord.
- Do not** handle plug or hand vacuum with wet hands or operate without shoes.
- Do not** put any objects into openings. Do not use with any opening blocked. Keep free of dust, lint, hair and anything else that may reduce air flow.
- Store your appliance indoors in a cool, dry area.
- Keep your work area well lit.
- Do not** immerse the hand vacuum into water or other liquids.
- Keep end of hose, wands and other openings away from your face and body.
- Use only on dry surfaces.
- Using improper voltage may result in damage to the motor and possible injury to the user. Correct voltage is listed on rating label.

SAVE THESE INSTRUCTIONS For Household Use Only



WARNING: To reduce the risk of electric shock, this appliance has a polarized plug (one blade is wider than the other). This plug will fit in a polarized outlet only one way. If the plug does not fit fully in the outlet, reverse the plug. If it still does not fit, contact a qualified electrician to install the proper outlet. Do not modify the plug in any way.

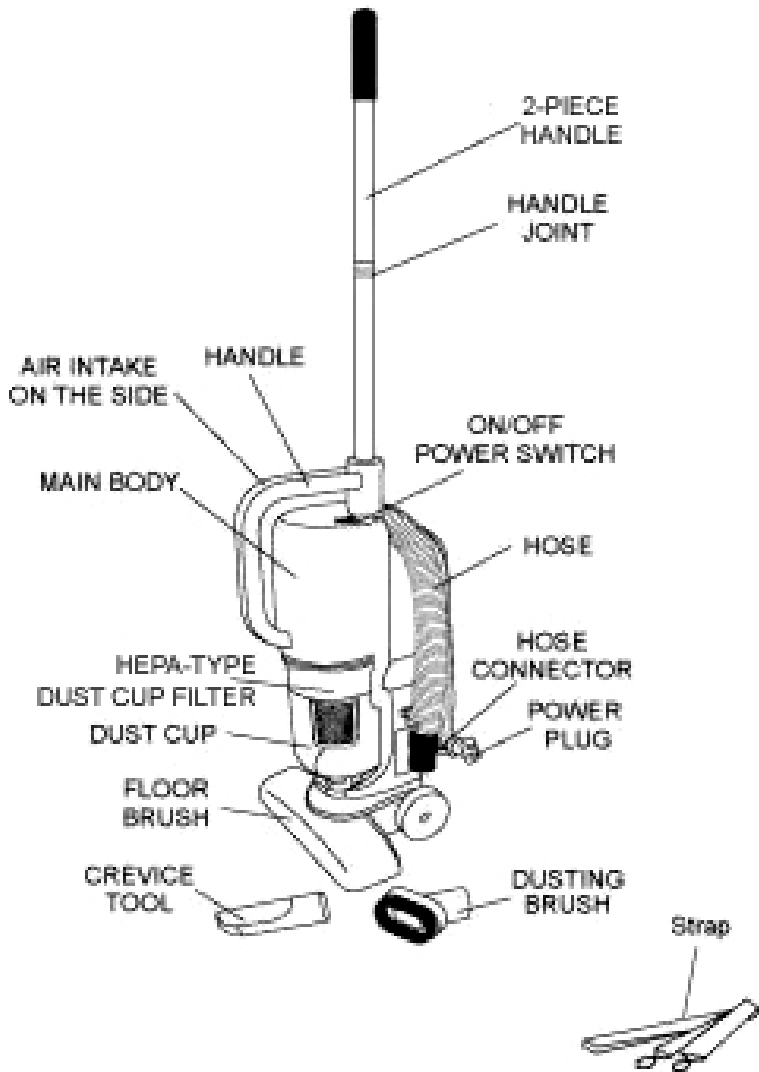

Technical Specifications

Voltage: 120V., 60Hz.
 Power: 7.5 Amps, 900 Watts

Replacing The Dust Cup Into The Unit

- Hold the dust cup in your hand.
- Make sure that the slot on the bottom of the cup is pointed in the same direction as the pins in the unit (see drawing #1).
- Slide the dust cup inside to the end of its place in the unit (see drawing #2).
- Turn the dust cup 90° in the direction shown in the drawing (#3) at right.
- The unit is now ready to be used again.



Note: To keep the vacuum cleaner looking new, it can be wiped with a damp cloth and a mild soap solution, then thoroughly dried. Never use any type of chemical cleaners as they can damage the vacuum cleaner. When not in use, store the vacuum cleaner in a dry, clean place.

Attaching the Shoulder Strap

Use the hooks to attach the shoulder strap to the vacuum cleaner.

Connect the dog leash swivel hooks to the eyelets located near the top of the unit handle and at the base of the unit. Adjust the strap as required for comfort.

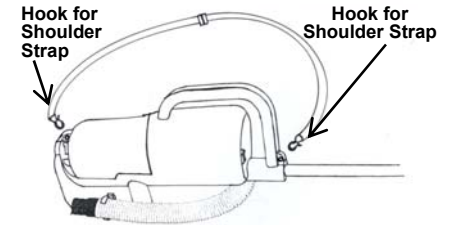

Warning: After extended use, the body of the vacuum cleaner may become hot. When using the unit with the shoulder strap, the unit will touch the body of the user. Therefore make sure to use the vacuum cleaner with the strap only when the unit is cool. If it gets too warm, allow it to cool before continuing to use it.

Motor Thermostat

IMPORTANT: This unit is equipped with a motor protective thermostat. If for some reason the vacuum cleaner should overheat, the thermostat will automatically turn the unit off. Should this occur:

- Push the On/Off button once.
- Disconnect the plug from the power source.
- Check the source of overheating problem. (i.e. clogged hose or filter).
- If clogged hose or filter is found, unclog the hose and replace the filters.
- Wait at least 45 minutes before attempting to reuse the vacuum.
- After unit has cooled down for 45 minutes, plug in the cleaner and push the On/Off button. The vacuum should start again.
- If the vacuum still does not start, contact customer service at 1 (800) 275-9251.

OPERATING INSTRUCTIONS cont.

NOTE: Always turn off the power switch and unplug the electrical cord before emptying the Dust Cup.

Cleaning & Changing the HEPA-TYPE Dust Cup Filter

1. After you have emptied the dust from the Dust Cup (container), separate the debris screen from the HEPA-Type filter cartridge by grasping the debris screen with one hand and the filter frame with the other and pull apart.

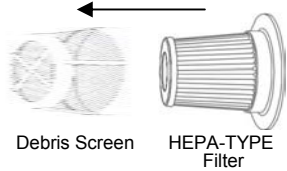

2. Rinse the debris screen under the faucet until clean. Allow to air dry or dry with a clean dish towel. Do **NOT** wash in dishwasher.
3. To clean the HEPA filter cartridge, hold filter by frame flange and tap filter on the inside wall of a dust container (garbage can).



Ensure that you do not damage the pleated filter material during cleaning. Also note that discoloration occurs during use. This does **NOT** affect the filter's performance.

4. Reassemble the debris screen to the HEPA-Type filter cartridge and replace into dust cup (container). Ensure that the filter assembly is completely seated inside the dust cup (container).
5. Attach the dust cup (container) to the vacuum.

Important: Do **NOT** use the HEPA-Type filter cartridge without the debris screen in place.

PLEASE NOTE: The white pleated filter material in the HEPA-TYPE Filter will discolor over time -This is NORMAL and will NOT affect the performance of the filter. If the HEPA-TYPE Filter is properly cleaned

after each use and suction does not return to 100%, then we suggest that the HEPA-TYPE Filter be cleaned vigorously until no more dust can be removed, then rinsed under the faucet and allowed to air dry for 24 hours before replacing into the vacuum. (Fig. A) **This should be done once a month or when suction appears to be reduced .**

NOTE: If you wash the HEPA-TYPE filter, make sure that it has completely air dried for 24 hours before inserting back in the vacuum.

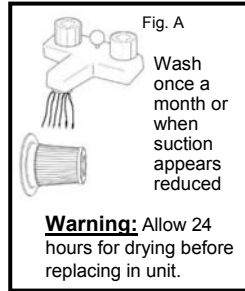

Warning: Always empty the dust cup and clean the HEPA-Type dust cup before each use and during prolonged usage. Never over fill the dust cup - remove dirt and clean the HEPA-Type dust cup filter during prolonged usage or risk motor damage. **Make sure that the debris screen and the HEPA-TYPE filter have completely air dried before replacing into the vacuum.**

PRECAUTIONARY MEASURES

IMPORTANT: If the suction opening in the unit or the hose is **BLOCKED**, switch off the vacuum cleaner and remove the blocking substance before you start the unit again.

1. Do not operate the vacuum cleaner too close to heaters, radiators or cigarette butts.



2. Before inserting the power plug into the wall outlet, make sure that your hands are dry.

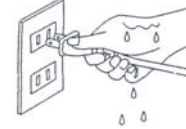

3. Before you start vacuuming, make sure to remove large or sharp objects that might damage the dust cup filter.



4. When pulling out the power plug from the wall outlet, pull the plug not the power cord.

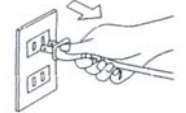

5. Do not pick up anything that is burning or smoking such as cigarettes, matches or hot ashes.

6. Do not use without dust cup filter in place.

OPERATING INSTRUCTIONS

NOTE: Always remove the power plug from the wall outlet before assembling or removing accessories.

INSERTING THE 2-PIECE METAL HANDLE INTO THE MAIN BODY

- Push in the pin at the end of the lower piece of the metal handle (see illustration).
- Insert the metal handle into the hole next to the handle. Make sure that the slot in the handle fits correctly into the opening. (See illustration.)
- When inserted correctly, the pin should rest in its hole.

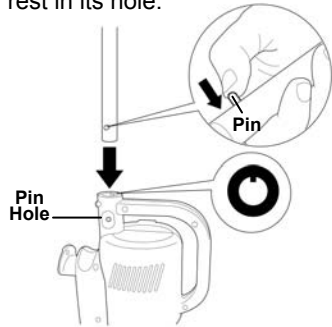

- To insert the upper piece of the metal handle, press on the pin that is on the upper handle and insert into the lower handle making sure that the pin comes out of the pinhole on the lower handle.

ATTACHING THE FLOOR BRUSH TO THE MAIN BODY

- Push in the pin in the floor attachment as shown in the illustration at right.
- Insert the floor brush into its location, in the direction of the arrow.
- When inserted correctly, the pin will show in the pin hole.

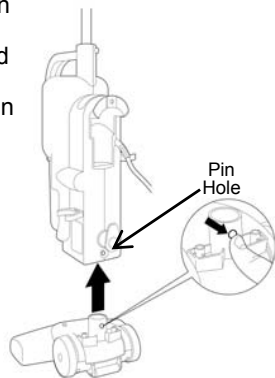

ATTACHING THE HOSE TO THE MAIN BODY

- Press in the pin at the end of the hose (see illustration below).
- Insert the hose into its place (see arrow in illustration).
- When inserted correctly, the pin will show in the pin hole.

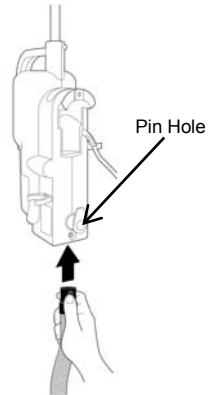

ON/OFF SWITCH

- The On/Off switch has two different positions.
- Push on the "I" side to turn the vacuum ON.
- Push on the "O" side to turn the vacuum OFF.

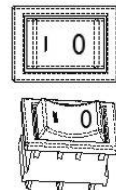
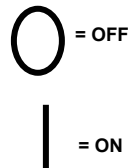

OPERATING INSTRUCTIONS cont.

WINDING & UNWINDING THE POWER CORD

- To wind the cord after usage, follow the illustration below.
- To unwind the power cord, follow the illustration below but in the opposite direction.

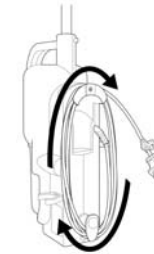

- When using the vacuum, attach the cord to the cord holder so that the cord is out of the way when you are vacuuming. (See below.)

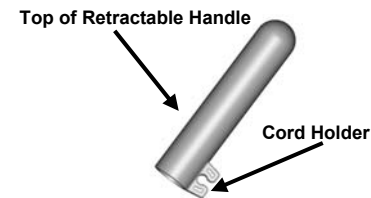

USING THE UNIT AS AN UPRIGHT

- Unwind the power cord and plug into the 120V outlet.
- Push down in the direction of the arrow to obtain best results on carpets or on hard wood floors.

NOTE: When vacuuming deep pile carpets or hard to vacuum carpets, lower the angle of the 2-piece metal handle (see illustration at below) for easier maneuverability.

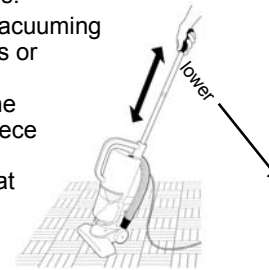

USING THE UNIT AS A HAND VACUUM

- Disconnect the metal handle. (See page 4.)
- Disconnect the floor brush. (See page 4.)
- Attach the hose. (See page 4.)
- Attach the crevice tool or the dusting brush. (See below.)
- Attach the shoulder strap. (See page 7.)

Crevice Tool

For radiators, crevices, corners, baseboards and between cushions.

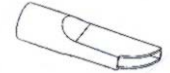

Dusting Brush

The dusting brush is used for the furniture, venetian blinds, books, lamp shades and shelves.



Emptying The Dust Cup

Warning: Always unplug the unit from electrical outlet before opening the Dust Cup (container).

- Hold the dust cup in your hand.
- Turn it a complete 90° in the direction shown in drawing #1. (Turning less than 90° will cause the dust cup to be attached on its bottom.)
- Let the dust cup come down slightly as shown in drawing #2.
- Slide the dust cup out towards you (see arrow in drawing #3).
- Hold the dust cup in your hand and remove the HEPA-Type dust cup filter (see drawing #4).
- Empty the dust cup (see drawing #5).

